

3W LED Driver Constant Current

SH-3-XXX IP65 SB

■ Approve
SELV 

■ Features

- Class II, SELV, built-in
- Input Voltage 100-240VAC
- Protections: SCP/OLP/OVP
- Power Factor >0.5
- IP65 Ingress protection
- Efficiency ≥68%
- 5 years warranty

■ Applications

- LED strips
- Spot light
- Wall light

■ Description

SH-3-XXX IP65 SB is a 3W constant current LED driver that operates from 90-264Vac input with 300 to 700mA output voltage. With it's compact dimensions from 37 x 23 x 21mm it is easy to integrate in LED strips, spot and wall light products. To ensure trouble-free operation, protection is provided against output short circuit and over Load.

■ Model code

SH-3-XXX IP65 SB

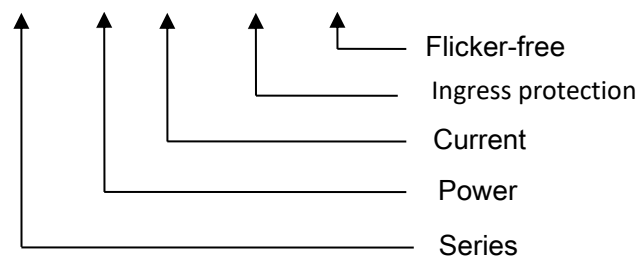

3W LED Driver Constant Current

SH-3-XXX IP65 SB

■ Specification

Input	Rated input voltage	100-240VAC			
	Range of input voltage	90-264VAC			
	Frequency(Hz)	50/60 Hz			
	Power Factor	>0.5@100-240VAC, full load			
	Input Current max	0.1A MAX @Full Load,90VAC			
	Start-up time	<0.5S			
	Unload Power Consumption	≤0.5W			
	Inrush Current	20A MAX. /110μs @230V, Full Load , 50%Ipk-50%Ipk			
	Leakage Current	< 0.7mA(240VAC)			
Output	Constant Current *Note.3	300mA	350mA	500mA	700mA
	Unload voltage Max.	20VDC	18VDC	15VDC	10VDC
	Voltage Range(VDC)	2.5-12VDC	2.5-10VDC	2.5-7VDC	2.5-4.5VDC
	Rated load	3.6W Max.	3.5W Max.	3.5W Max.	3W Max.
	Current Accuracy	± 5% @100-240VAC			
	Voltage Regulation	± 5% @Full Load ,100-240VAC			
	Load Regulation	± 5%@100-240VAC			
	Hold-up Time	1s max. Full Load			
	Ripple& Noise *Note.2	< ±5% @Full Load , 230Vac			
	Efficiency(Typ.)	≥68%			
Protection	Over Load Protection	103-150% Protection type: Auto Resume			
	Over Voltage Protection	>20VDC	>18VDC	>15VDC	>10VDC
	Short circuit Protection	Protection type: Auto Resume			
Environment	Operating Temperature	-20°C...+50°C			
	tc	75°C			
	Storage Temperature	-20°C...+60°C			
	Humidity	10%-90%RH			
	Life time	> 30,000h @50°C			
Others	Dimension	37X23X21(LXWXH)mm			
Safety & EMC	Safety standards	EN 61347-1; EN61347-2-13 ; EN62384			
	Withstand voltage	Input-Output : 3750V/5mA/1min			
	Isolation resistance	Input-Output : ≥4MΩ@500VDC			
	EMI	EN55015 Class II; EN61000-3-2 Class A; EN61000-3-3			
	EMS	EN 61547;EN 61000-4-2 — Performance Criteria B; EN 61000-4-5 —500V; Performance Criteria C			
Note	1.All parameters NOT specially mentioned are measured at 230VAC input , full load and 25°C of ambient temperature. 2.Ripple & Noise are measured at 20MHz of bandwidth by using a 300mm twisted pair-wire terminated with a 0.1uF & 47 uF parallel capacitor. 3.Output current can be from 300mA to 700mA . Please see Model list below and contact EAGLERISE for details.				

3W LED Driver Constant Current

SH-3-XXX IP65 SB

Model list

Model number	Input			Output			
	Voltage (VAC)	Max.Current (A)	Frequency (Hz)	Constant current (mA)	Normal working voltage (VDC)	No load working voltage (VDC)	Max. Power(W)
SH-3-300 IP65 SB	100-240	0.1	50/60	300	2.5-12	20	3.6
SH-3-350 IP65 SB				350	2.5-10	18	3.5
SH-3-500 IP65 SB				500	2.5-7	15	3.5
SH-3-700 IP65 SB				700	2.5-4.5	10	3

Wiring diagram

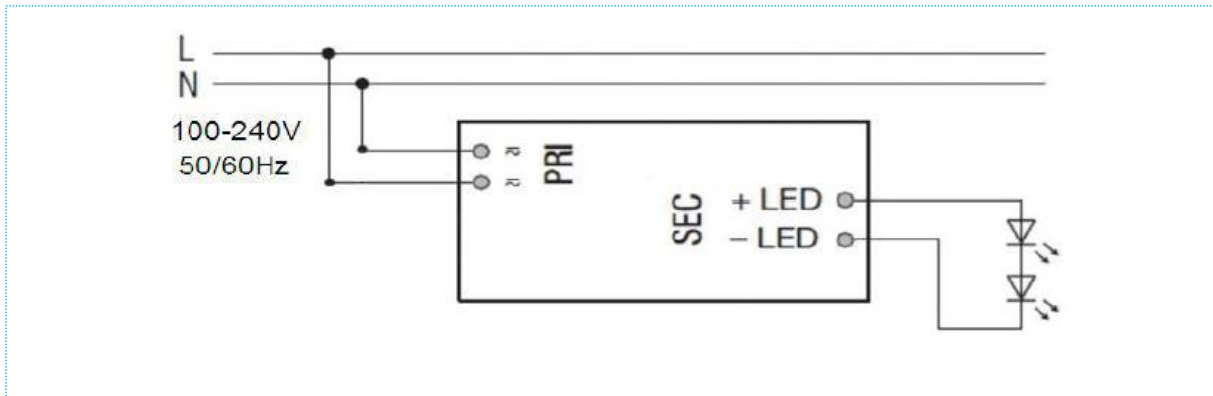

2D diagram

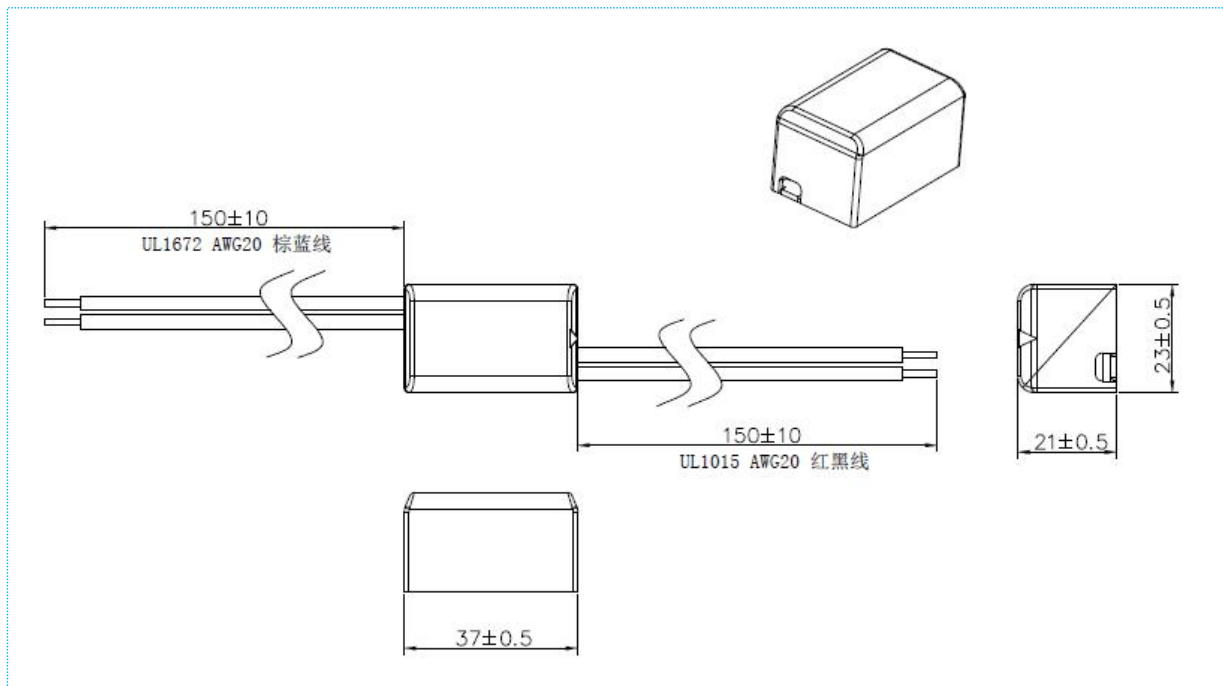

3W LED Driver Constant Current

SH-3-XXX IP65 SB

Curve@SH-3-700 IP65 SB

Lifetime vs. Ambient Temperature Curve

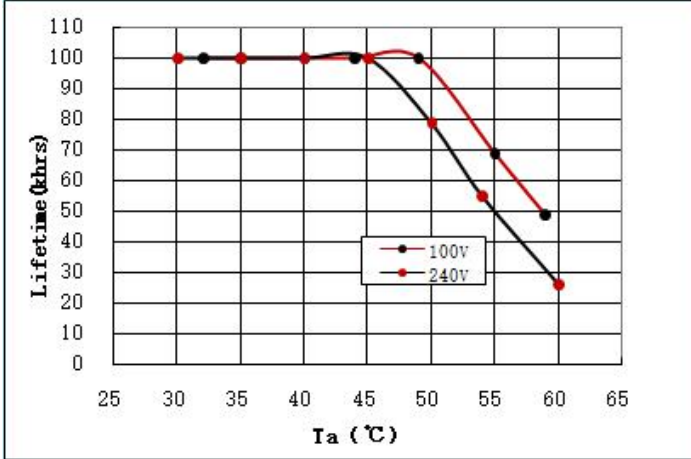

Efficiency vs. Load

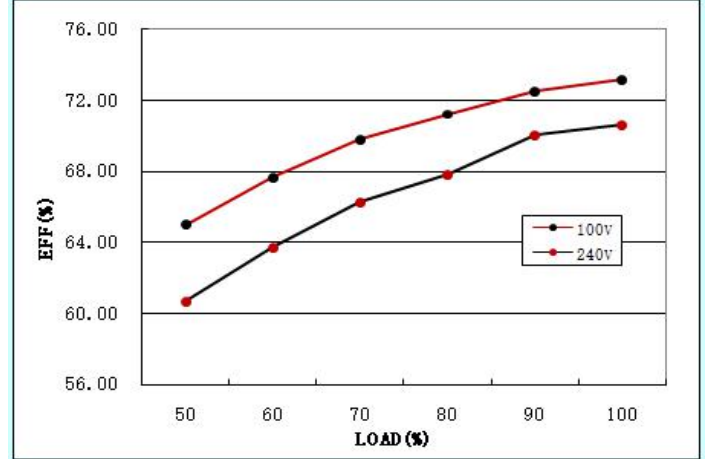

Power Factor Characteristics

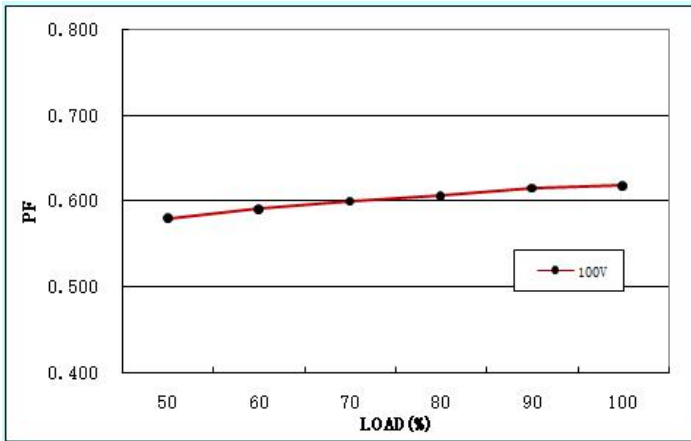

THD vs. Load

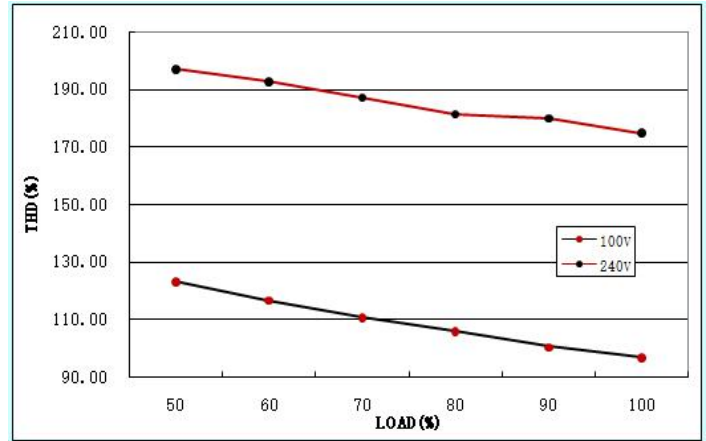

Operating window

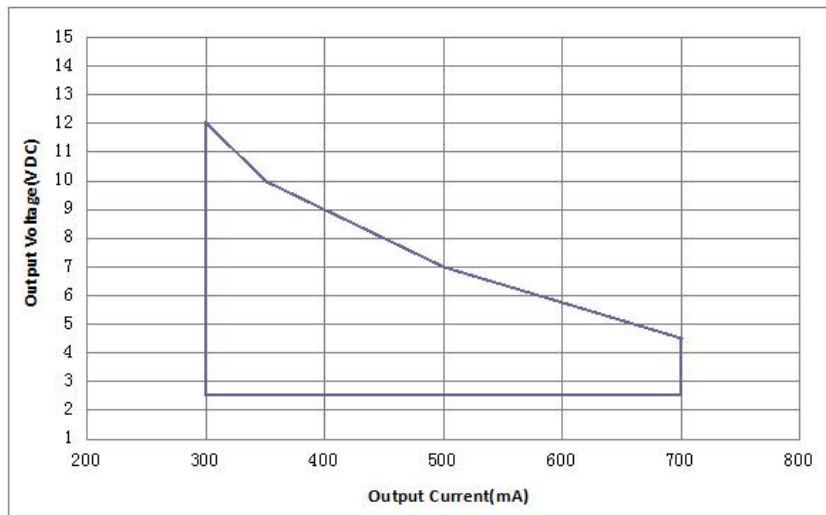

Operating window 100%