



## 50W DALI-2 'Dim to Dark' LED Driver

### SOLOdrive

LED dimming made beautiful - SOLOdrive offers industry-best Natural Dimming to dark, with any dimmer, in any application. The SOLOdrive works seamlessly with LED modules, controls and intelligent luminaire elements.

### Product offering



### SOLOdrive 560/A

Part number (P/N)	SL0560A3
Product description	SOLOdrive, 50W, DALI-2, 1 control channel, constant current, 2x 55V output, side feed, square metal/plastic

### Features & benefits

Natural dimming	Dim to dark, smooth brightness changes, excellent flicker performance, adaptable dimming curves, configurable minimum dimming level
LightShape	Dim to Warm: decrease colour temperature when dimming
LEDcode	LEDcode2 connects to integrated digital accessories, supports location-based IoT applications and enables wired and wireless lighting control through LEDcode peripheral devices
Programmable	Fine-tune your driver for any application
Performance	Universal input voltage range, low inrush current and total harmonic distortion (THD), high power factor and efficiency
Camera compatibility	Hybrid HydraDrive technology is proven to work in TV studios and security camera environments

### Programming tools

Programming interface	<a href="#">TOOLbox pro (TLU20504)</a>
Programming cable set	<a href="#">TOOLbox pro to LED driver, programming cable, 5pcs (TLC03051)</a>
Programming Hand-held, Touch-and-Go	<a href="#">PJ0035HH1</a>
Programming jig	<a href="#">PJ0500S1</a>
Programming software	<a href="#">FluxTool</a>

### Warranty

Warranty period	<a href="#">General Terms and Conditions</a>
-----------------	--

### Order number configurator

<b>Standard</b>	<p><b>SL0560A3</b> Part Number</p> <p>□□□□ mA LED Output Current</p> <p>□□□ Dimming Curve</p> <p>□□ . □ min Minimum Dimming Level</p>
<b>Multi-Current</b>	<p><b>SL0560A3</b> Part Number</p> <p><b>M C U R</b> □□□ □□□ . □ min <b>CH1 -</b> □□□□ mA</p> <p>LED Output Current Dimming Curve Minimum Dimming Level LED Output 1</p> <p><b>CH2 -</b> □□□□ mA</p> <p>LED Output 2</p>
<b>LightShape</b>	<p><b>SL0560A3</b> Part Number</p> <p>□□□□ mA <b>D T W</b> □□□ □□□ - □□□ K □□□ - □□□ lm</p> <p>LED Output Current LightShape Control Type Dimming Curve Gamut CCT Gamut Lumen Output</p> <p>□□□ - □□□ K</p> <p>Path CCT</p>
<b>LightShape Multi-Current</b>	<p><b>SL0560A3</b> Part Number</p> <p><b>M C U R</b> <b>D T W</b> □□□ <b>CH1 -</b> □□□□ mA <b>CH2 -</b> □□□□ mA</p> <p>LED Output Current LightShape Control Type Dimming Curve LED Output 1 LED Output 2</p> <p>□□□ - □□□ K □□□ - □□□ lm □□□ - □□□ K</p> <p>Gamut CCT Gamut Lumen Output Path CCT</p>

**Example:** SL0560A3 MCUR DTW LOG CH1-300mA CH2-400mA 18-50K 10-12lm 18-50K

LED output current, Standard	For models where output current is identical for all outputs. Enter value in 1mA increments, e.g. "811" for 811mA.
LED output current, Multi-Current	Output current different per output? Enter "MCUR" in LED output current and specify the differing currents in LED outputs 1 and 2. Note that cumulative current is limited.
LightShape control type	"DTW" stands for Dim to Warm
Dimming curve	"LOG" for logarithmic (default) "LIN" for linear
Minimum dimming level	Leave blank for default minimum dimming level of 0.1%. Specify in 0.1% increments, e.g. "10.5" for 10.5%.
Gamut CCT	LightShape-specific option. Enter the LEDs' CCT as "XX-YY" where XX is LED output 1 and YY is LED output 2. Available options per output: 18, 20, 22, 25, 27, 30, 35, 40, 50, 57 and 65. E.g. "18-50" for 1800K on LED output 1 and 5000K on LED output 2.  Default is 27-65
Gamut lumen output	Enter the lumen output range for LED output 1 and 2 as "XX-YY" where XX is LED output 1 and YY is LED output 2. Available range per output: from "01" for 100lm to "99" for 9900lm. E.g. "10-12" for 1000lm on LED output 1 and 1200lm on LED output 2.
Path CCT	Leave blank if Path CCT requires the same values as Gamut CCT. Or specify the Path CCT values as "XX-YY" where XX is LED output 1 and YY is LED output 2. Available options per output: 18, 20, 22, 25, 27, 30, 35, 40, 50, 57, 65. E.g. "18-50" for 1800K on LED output 1 and 5000K on LED output 2.

---

## Input characteristics

---

Nominal input voltage range	120 - 250 VAC (ENEC), 120 - 277 VAC (UL) 120 - 250 VDC
-----------------------------	---

---

Absolute input voltage range	108 - 305 VAC
------------------------------	---------------

---

Input frequency range	50 - 60 Hz
-----------------------	------------

---

Maximum input current	0.65A @ 120 VAC 0.36A @ 230 VAC 0.30A @ 277 VAC
-----------------------	---

---

Efficiency at full load	87.5%
-------------------------	-------

---

Power factor at full load	> 0.95
---------------------------	--------

---

THD at full load	< 15%
------------------	-------

---

Maximum inrush current	< 100mA <sup>2</sup> s @ 120 VAC < 100mA <sup>2</sup> s @ 230 VAC < 100mA <sup>2</sup> s @ 277 VAC
------------------------	--

---

Surge protection	2kV differential mode (DM) 2kV common mode (CM)
------------------	--

---

Maximum standby power	< 0.5W
-----------------------	--------

---

**Output characteristics**

Maximum LED output power	50W
Number of LED outputs	2 (UL Class 2)
Programmable LED output current range	150 - 1400mA
LED output type	Programmable in 1mA increments within specified current range
LED output current tolerance	+/- 5% at programmed LED output current
LED output voltage range	2 - 55V

Operating window

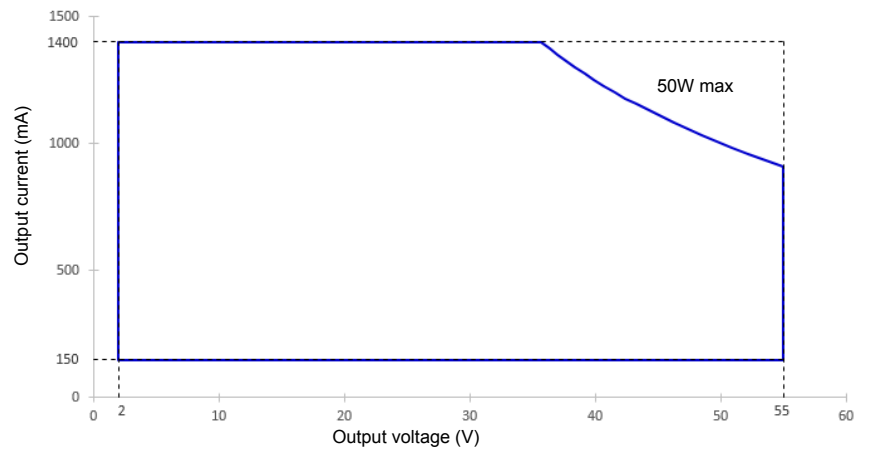

**Control characteristics**

Control channels	1
Control protocol	DALI-2 Device Type 6 LEDcode2
Dimming range	100% - 0.1%
Dimming curve options	Logarithmic (default) Linear
LightShape	Dim to Warm, 2x pc-white
Dimming method	Hybrid HydraDrive
Time delay to standby	< 30s

Dimming curves

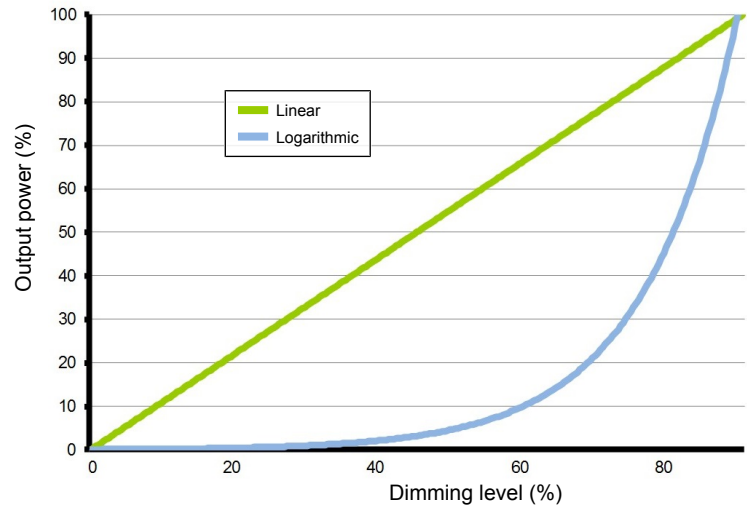

## Performance

### Typical efficiency vs load

Tested with a load on each LED output of 16 LEDs in series, programmed for 1000mA and at 25 °C ambient temperature. The measurements below 50W were performed by dimming the light output.

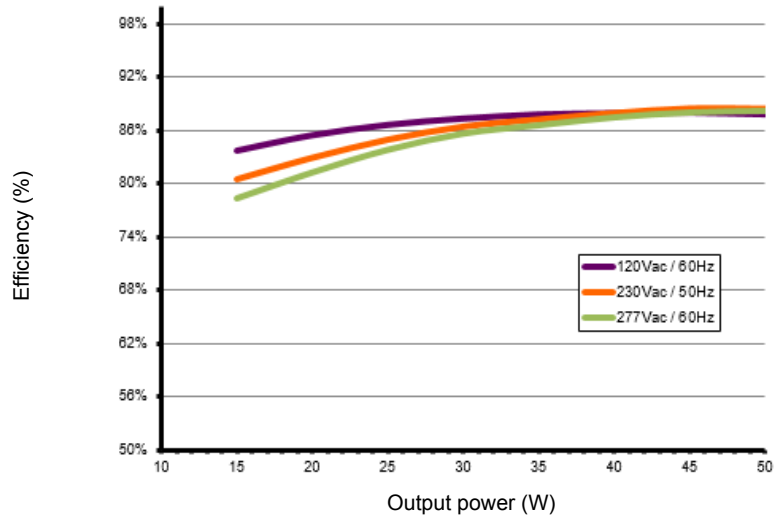

### Typical power factor vs load

Tested with a load on each LED output of 16 LEDs in series, programmed for 1000mA and at 25 °C ambient temperature. The measurements below 50W were performed by dimming the light output.

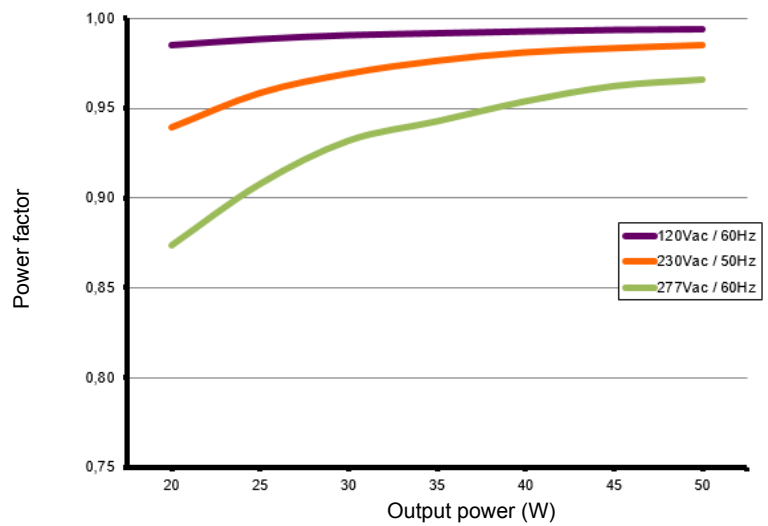

### Typical THD vs load

Tested with a load on each LED output of 16 LEDs in series, programmed for 1000mA and at 25 °C ambient temperature. The measurements below 50W were performed by dimming the light output.

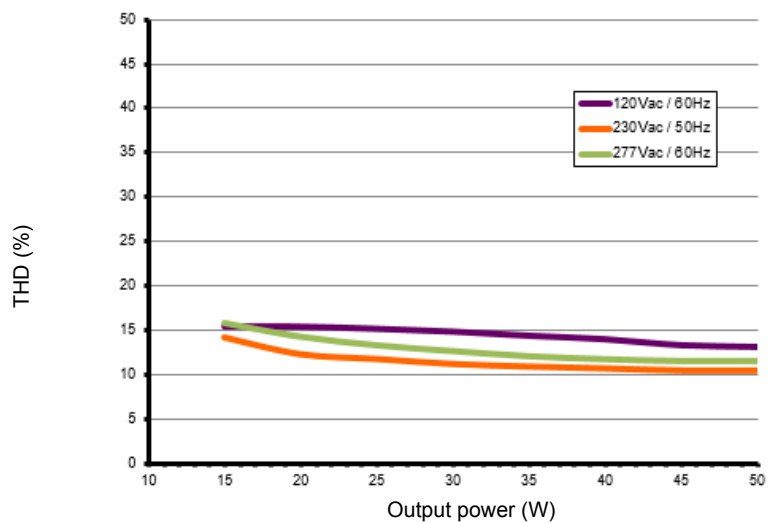

Typical flicker performance

Typical flicker percent as a function of frequency, measured across the dimming range. The results are overlaid with the low-risk (yellow) and no observable effect (green) levels as defined in IEEE P1789.

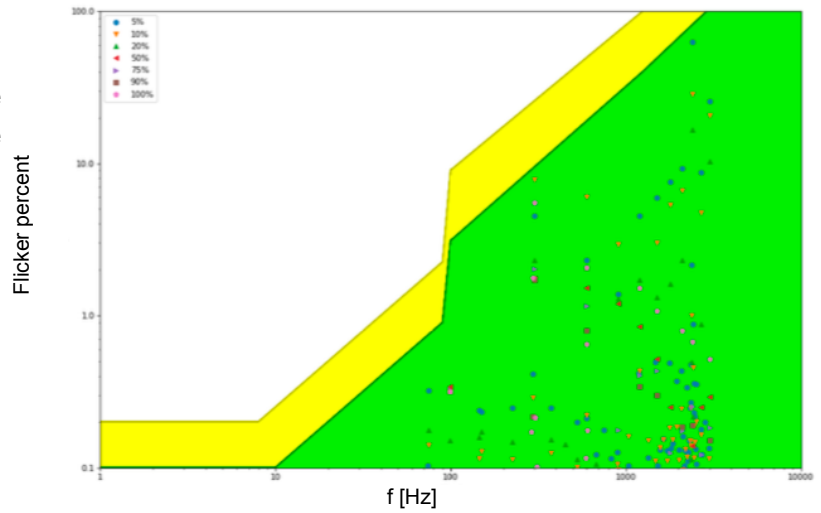

Environmental conditions

Operating ambient temperature (Ta) range -20 °C to +50 °C

Maximum operating case temperature (Tc max) 83 °C

Acoustic noise – steady state <24dBA (Class A)

Lifetime 50,000 hours at a maximum case temperature (Tc) of 76 °C

UL Type TL  
 Measured Tref: 63 °C  
 Maximum allowed Tref: 83 °C  
 Measured at 1400mA

Tc point location

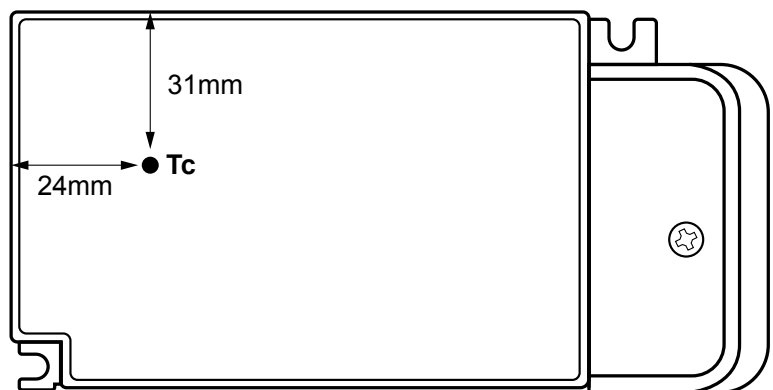



## LED driver protection

Thermal	The LED output current is automatically decreased whenever the internal driver temperature exceeds a factory preset temperature. The LED output current is increased once the internal driver temperature drops below the preset temperature threshold. If the internal driver temperature continues to increase, despite a decrease in output current, the LED driver will eventually shut down.
LED output short circuit	The LED output current is cut off whenever the LED driver detects a short-circuit. The LED driver will attempt a restart every 400ms after a short-circuit is detected.
LED output open circuit	All LED outputs are turned off whenever the LED driver detects an open circuit on any one of the LED outputs. The LED driver will automatically attempt a restart every 400ms after an open circuit is detected.
LED output overload	The driver monitors the cumulative load across all LED outputs. Whenever this cumulative load exceeds the maximum output power rating of the LED driver, the output current on all LED outputs is sequentially scaled down until the cumulative load drops below the maximum output power rating of the LED driver.
Reverse polarity	The LED driver will not yield any current if the polarity of the load on the LED output is reversed. This situation will not damage the LED driver but may damage the LED load.

## LED protection

Thermal protection LED	An external NTC thermistor, which is placed on a PCB near the LEDs, can be connected to the driver via the LEDcode/NTC terminals. The output current to the LEDs is then decreased by 75% whenever the NTC exceeds a maximum allowable temperature, which is specified by the user in the FluxTool software. The default NTC temperature limit is set to 70 °C.
Thermistor value	47kΩ
Suitable thermistors	Leaded: Vishay, P/N 238164063473 Screw: Vishay, P/N NTCASCWE3473J

**LED driver mechanical details**

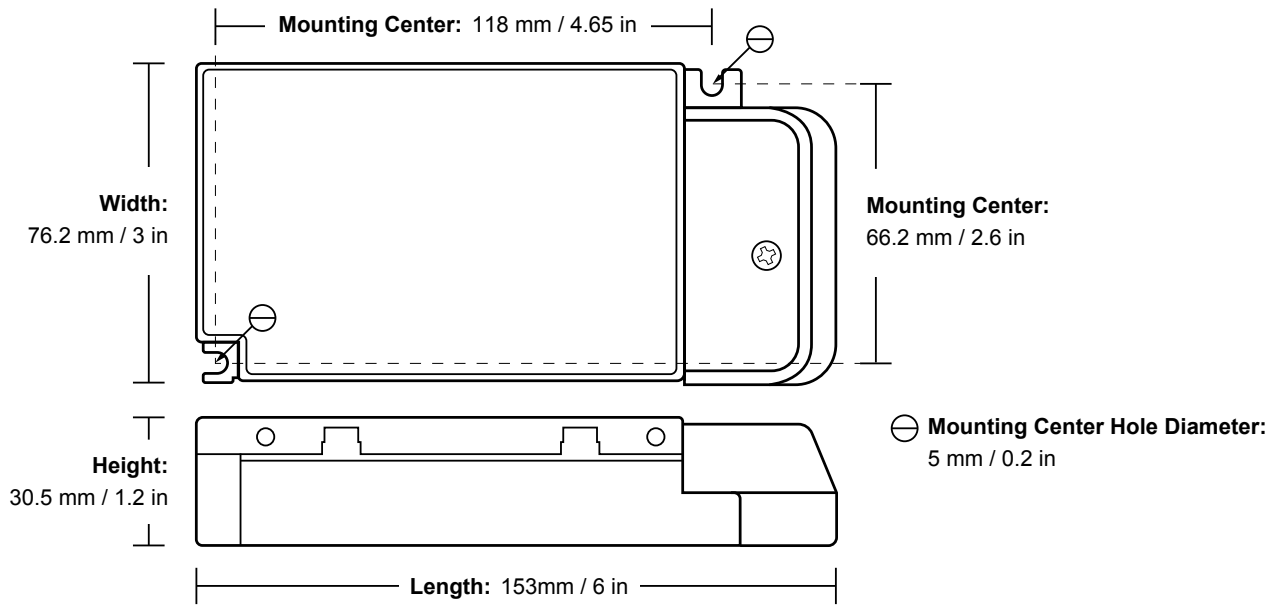

Weight	293 g
Mounting torque	Not to exceed 0.5Nm

3D Mechanical files for this product are available on the eldoLED website.

**Packaging**

Length x Width x Height	508 x 305 x 178 mm / 20 x 12 x 7 in
Weight (including products)	15 kg
Products per box	40 pcs

**Connector layout**

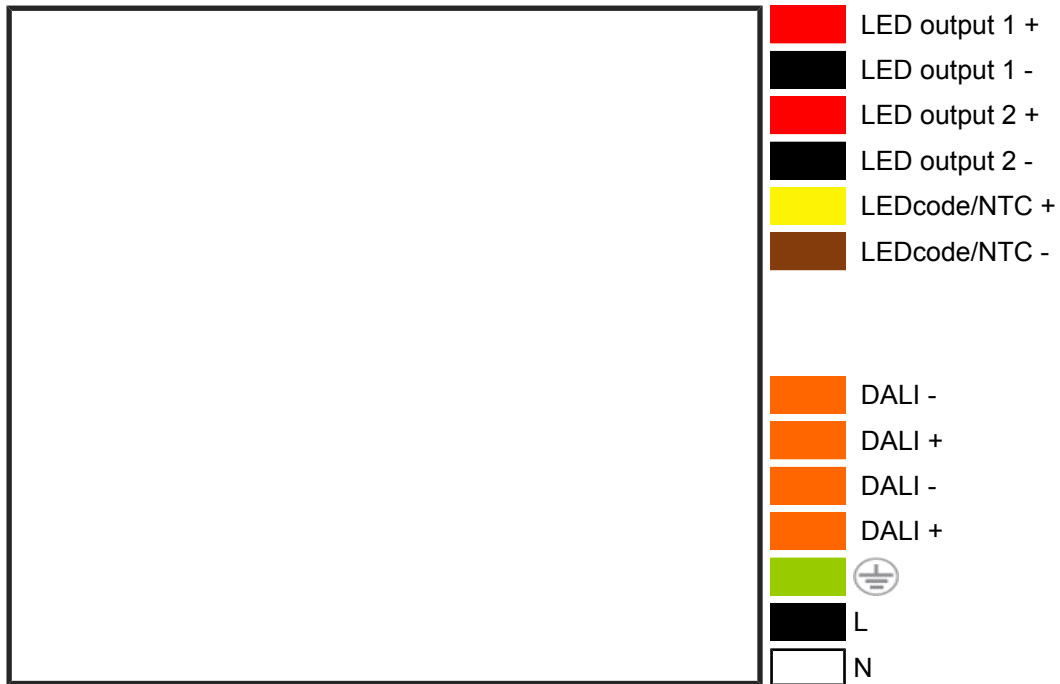

**Input wiring specifications**

Connector type	push-in terminals
Connector supplier and series	Wago 250 series
Wire type	solid or stranded copper
Wire core cross section	0.5 - 1.5mm <sup>2</sup> / AWG 20 – 16
Wire strip length	9.0mm (11/32in)

**Output wiring specifications**

Connector type	push-in terminals
Connector supplier and series	Wago 250 series
Wire type	solid or stranded copper
Wire core cross section	0.5 - 1.5mm <sup>2</sup> / AWG 20 – 16
Wire strip length	9.0mm (11/32in)
Maximum remote mounting distance of LED load	For independent use: 2 m / 6.5 ft For in-fixture use: AWG 20 (0.52 mm <sup>2</sup> ) - 14 m / 46 ft AWG 19 (0.65 mm <sup>2</sup> ) - 18 m / 59 ft AWG 18 (0.82 mm <sup>2</sup> ) - 22 m / 72 ft AWG 17 (1.04 mm <sup>2</sup> ) - 28 m / 92 ft AWG 16 (1.31 mm <sup>2</sup> ) - 36 m / 118 ft

**Automatic circuit breakers (MCB)**

Maximum loading	MCB type	B10	B13	B16	C10	C13	C16
	Number of LED drivers	14	18	22	14	18	22

**RCM independent control gear classification**

Regulation AS/NZS 60598.2.2

Applies when the control gear is built inside constructions

<b>Clearance type</b>	<b>Description</b>	<b>Distance</b>
Height clearance to building element (HCB)	Minimum distance between the top of the control gear and any building element above it	50 mm
Minimum insulation clearance (MIC)	Minimum distance between the top of the control gear and the building insulation above it	50 mm
Side clearance to building element (SCB)	Minimum distance between the side of the control gear and any building element	50 mm
Side clearance to insulation (SCI)	Minimum distance between the side of the control gear and any building insulation	50 mm

RISK OF FIRE

BUILDING INSULATION MUST NOT COVER THE CONTROL GEAR

## Standards and compliance

UL, recognized component	UL 1310 UL 8750 (Class 2 output). Type TL LED driver.
ENEC safety	EN 61347-1 EN 61347-2-13 (Emergency lighting)
ENEC performance	EN 62384
Conducted emissions	EN 55015 FCC title 47 CFR part 15 class B
Radiated emissions	EN 55015 FCC title 47 CFR part 15 class B
Radio disturbance characteristics	EN 55022
Harmonic current emissions	EN 61000-3-2
Electrostatic discharge	EN 61000-4-2
RFE field susceptibility	EN 61000-4-3
Electrical fast transient	EN 61000-4-4
Surge immunity	EN 61000-4-5
Conducted radio frequency	EN 61000-4-6
Voltage dips	EN 61000-4-11
Electromagnetic immunity	EN 61547
ECODesign 2019/2020: Controlgear + luminaire	Flicker for LED: Pst LM $\leq$ 1.0 at full-load Stroboscopic effect for LED: SVM $\leq$ 0.4 at full load
DALI-2	IEC 62386-101 Edition 2.0, IEC 62386-102 Edition 2.0, IEC 62386-207 Edition 1
Surge protection	IEC 61000-4-5 level 3: 2kV DM, 2kV CM @ 2 Ohm
Surge protection	ANSI 62.41 1991 category B1: 2.5kV DM, 2.5kV CM @ 30 Ohm DALI input: 0.5 kV DM, 1 kV CM surge
RCM	AS/NZS 61347.1, AS/NZS 61347.2.13
Restriction of hazardous substances	RoHS3 (Directives 2011/65/EU-2015/863/EU)
SVHC-list substances	REACH Art.33

Certifications



Safety



An independent control gear that can be used where normally flammable materials, including building insulation, are or may be present, but cannot be abutted against any material and cannot be covered in normal use.



FELV control terminals marked “Risk of electric shock” are not safe to touch. Dimming connected to FELV control terminal shall be insulated for Low Voltage supply of the control gear. Any terminals connected to the FELV circuit shall be protected against accidental contact.



Risk of electrical shock. May result in serious injury or death. Disconnect power before servicing or installing.



The LED driver may only be connected and installed by a qualified electrician. All applicable regulations, legislation, and building codes must be observed. Incorrect installation of the LED driver can cause irreparable damage to the LED driver and the connected LEDs.

Pay attention when connecting the LEDs: polarity reversal results in no light output and often damages the LEDs.



LED drivers are designed and intended to operate LED loads only. Powering non-LED loads may push the LED driver outside its specified design limits and is, therefore, not covered by any warranty.



eldoLED products are designed to meet the performance specifications as outlined at certain operating conditions in the data sheet. It is the responsibility of the fixture manufacturer to test and validate the design and operation of the system under expected and potential use cases, including faults.



Please observe voltage drop over long cable lengths. Longer cable lengths increase EMI susceptibility.



Product renderings and dimensional drawings are generic for the housing type. Product label, connector type and quantity may vary.

---

**Europe, Rest of World**

eldoLED B.V.  
Science Park Eindhoven 5125  
5692 ED Son  
The Netherlands

E: [info@eldoled.com](mailto:info@eldoled.com)  
W: [www.eldoled.com](http://www.eldoled.com)

**North America**

eldoLED America  
One Lithonia Way  
Conyers, GA 30012  
USA

E: [info@eldoled.com](mailto:info@eldoled.com)  
W: [www.eldoled.com](http://www.eldoled.com)

---